

MobileCrimp® 4-20

Safety & Operating Manual

**Digital
Dial
Control**



Digital Dial Control

Prod. No.: 7480-0051, Part No.: 77421

Dimensions: 12 1/4" wide x 6 1/4" deep x 19 1/2" high

Weight: 57 lbs. (with stand)

Pump Specifications

All pumps maximum rated working pressure: 10,000 psi

Shop Air Pump

Prod. No.: 7481-0002, Part No.: 77820

Weight: 10 lbs.

1/4 H.P. 12 Volt DC Pump

Prod. No.: 7481-0037, Part No.: 77439

Weight: 20.5 lbs.

1/2 H.P. 115 Volt AC Pump

Prod. No.: 7481-0034, Part No.: 77441

Weight: 32 lbs.

Hand Pump

Prod. No.: 7481-0006, Part No.: 77821

Weight: 25.6 lbs.

1/4 H.P. 115 Volt AC Pump

Prod. No.: 7481-0033, Part No.: 77440

Weight: 20 lbs.

1-1/2 H.P. 115 Volt AC Pump

Prod. No.: 7481-0035, Part No.: 77442

Weight: 108 lbs.

Carefully read and understand the following warnings before operating this crimper.

WARNING!

An incorrect hose assembly can rupture or blow apart in use, resulting in serious injury, death or property damage. **REMEMBER:** Others depend on you to make correct assemblies.

FOR SAFETY'S SAKE

USE THIS MACHINE ONLY IF YOU:

1. Receive hands-on **TRAINING** with the **MobileCrimp® 4-20** and Gates assemblies.
2. Follow current **GATES OPERATING MANUAL AND CRIMP DATA** for the **MobileCrimp 4-20**.
3. Use only **NEW (UNUSED) GATES** hose and fittings.
4. Wear **SAFETY GLASSES**.
5. **KEEP HANDS CLEAR OF MOVING PARTS.** Support hose with one hand while activating pump with other hand.
6. **DO NOT** operate pump **UNLESS** cylinder is locked in crimp position.
7. To avoid risk of injury, **DO NOT** use crimper **UNLESS CONTROLLER BASE PLATE** is in place.
8. **DO NOT** operate crimper in horizontal position.



Serial No. _____
(Located on front top of cylinder)

Date of Purchase _____

Contents

Identification List	2
Setup	3
Hose Preparation	7
Operating Instructions	9
Measuring and Adjusting the Crimp Diameter	13
Maintenance	14
Troubleshooting	15
Replacement Parts List	16
Warranty	inside back cover



Identification List

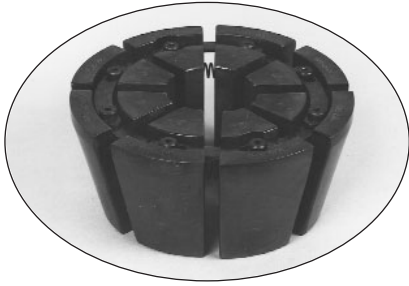

Die



Molykote and Brush

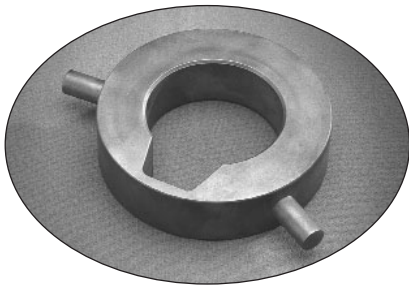

Pressure Plate



Crimper

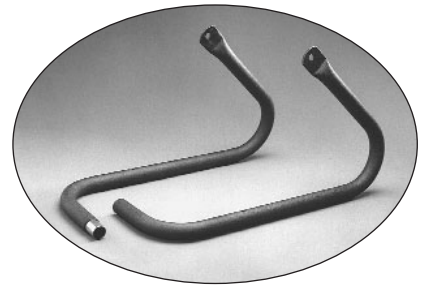

Stand

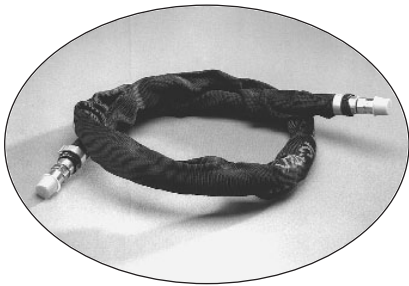

Hose Assembly

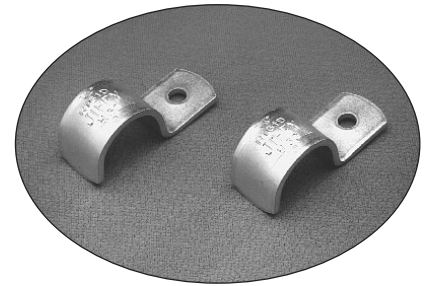

Clamps

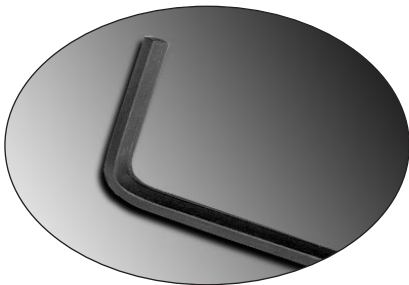

.05 Allen Wrench



Literature Packet



Magnet

Setup

1. Unpack carton.

- Remove crimper, pressure plate (1), nylon-covered hose assembly (1), literature envelope (1), stand (2 pieces), magnet (1) .05 Allen wrench (1) and Molykote lubricant (1) from shipping carton. Locate the serial number assigned to the crimper on the top front of the cylinder and record on page one for future reference.

2. Attach crimper to the stand.

- Place crimper on flat, well-supported surface (such as the top of a workbench or the bed of a service vehicle) with the handle to the right.
- Remove two (2) knobs, flat washers (2) and spacer (1) from crimper pivot bolts.



- Slide the two halves of the stand together and attach to the crimper at the pivot bolts.



- Replace spacer, flat washers and knobs. Do not tighten knobs.

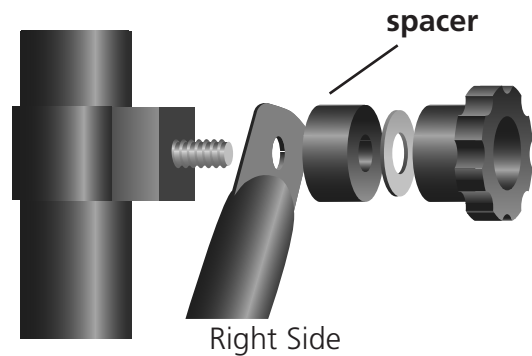
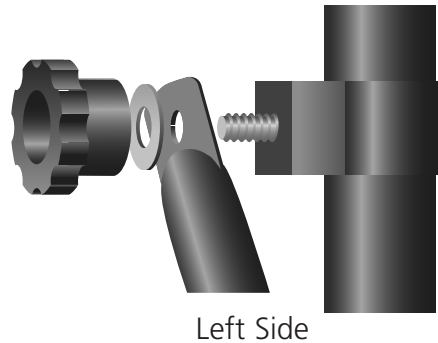

- Lift crimper and allow stand to swing down onto the surface. Tighten knobs.



3. Fasten crimper to work surface before use (to avoid damage to machine or personal injury because an unsecured machine can fall).

- Position crimper so that mounting holes are approximately 7" to 8" from the edge of the work surface.
- Mark the drilling location using the mounting holes as a guide (see illustration below).

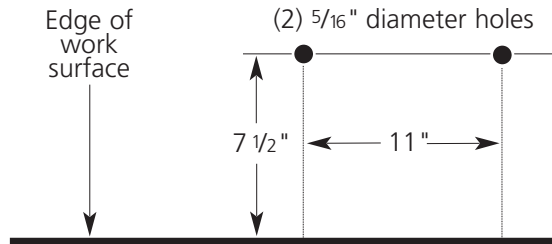

- Drill two 5/16" diameter holes.
- Use mounting holes or clamps to fasten stand to work surface.

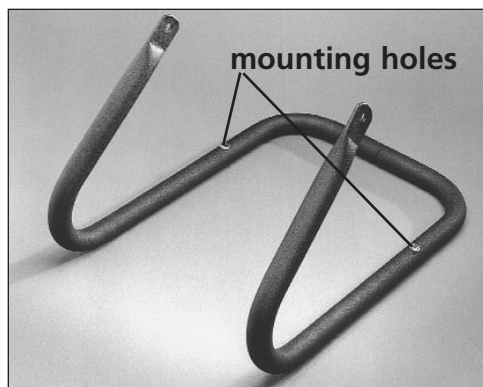
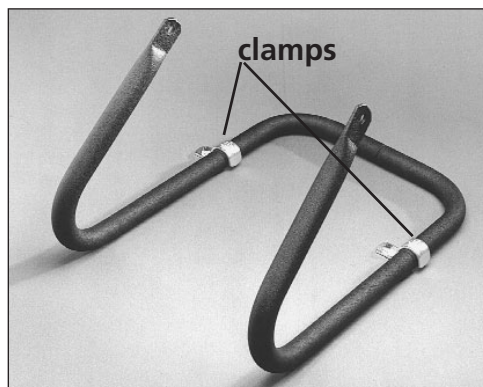

THINK SAFETY!

To avoid damage to the machine or injury to you, ALWAYS fasten the crimper to the work surface before you attempt to crimp.

4. Attach pump to crimper.

- Place pump near crimper.
- Connect hose assembly to the pump port (3/8" NPT threads). Pipe sealant may be used to seal connection. (For best connection, use Gates' Quick Disconnect couplings, G95311-0606 and G95321-0606, sold separately.)



- Connect opposite end to the adapter on crimper.



5. Check pump oil level.

- Pump comes with oil in reservoir.
- Check proper oil level per pump operating manual instructions or the Maintenance Section (p. 14) of this manual.

6. Connect pump to power outlet.

- For 115V connection, plug power cord into a properly grounded and rated circuit (see inside cover for circuit requirements).
- For vehicle battery connection, see pump operating manual.

7. Bleed air from system.

- Tilt crimper forward so adapter is at its highest point.



- Turn the knob on the controller to a setting of **400**, which allows the ram to extend approximately 1".



- Turn pump on by pressing and holding the power "on" switch, (see pump operating manual for switch location) which extends the ram.



CAUTION

Keep away from all moving parts!
If bodily contact with a moving part occurs, immediately release the pump power "on" switch.

- When the light comes on and buzzer sounds, immediately release "on" switch allowing ram to fully retract. **NOTE:** If light and buzzer are faint or do not work, the controller batteries may need replacement. See "Maintenance" section of this manual.

- Repeat a minimum of five (5) times to bleed air completely.

8. Place crimper in comfortable working position.

- See photo below for suggested working position.



IMPORTANT

Do not operate crimper in horizontal position because dies will become unstable.

THINK SAFETY!

Note: It's a good idea to place a rubber mat on the floor near the crimper to reduce the chance of damaging a die if dropped and improve operator comfort.

9. Calibrate.

- Before crimping a hose assembly, check calibration.

Calibration is the proper relationship between a setting and the crimp diameter. It should be checked at least monthly, possibly weekly or daily, if crimper has been used heavily or abused.

- Place the MC33 die set into the die cone and install pressure plate.



- Turn the knob to a setting of 245.



Note: Rotating the knob on front of switch box clockwise will increase the number; counterclockwise will decrease the number. When changing the setting, always move to a higher number then down to the desired setting. (Example: To change from 200 to 245, move dial up to 300 then down to 245.)

- Insert an 8G MegaCrimp® coupling into the die set.



- Complete the crimp.
- Remove the coupling and measure the crimp diameter, which should measure 1.000" \pm .003". To properly measure crimp diameter, refer to page 13.

- If the crimp diameter *is* within this range, no adjustment is necessary.
- If the crimp diameter *is not* within this range, the crimper must be calibrated.
- To get a smaller crimp diameter, change the setting to a smaller number.
- To get a larger crimp diameter, change the setting to a larger number.
- For every .001" change in crimp diameter, change the setting by 002. For example, to increase the crimp diameter by .002", increase your setting from 245 to 247.
- Turn the knob to this new setting and crimp a new coupling.
- After the correct diameter is achieved, pull the plastic cap from the knob.



- Loosen the two (2) set screws in the brass knob 1/4 to 1/2 turn using a .05" Allen wrench.



- Turn the brass knob either clockwise or counterclockwise to get the setting back to 245.



- Tighten the set screws and replace the plastic cap.
- Crimper is now calibrated.

Hose Preparation

MegaCrimp® Pre-Assembled Couplings.

CAUTION

A new hose and end fittings must be used when building a hose assembly. Re-using any components will seriously affect performance and could result in serious injury or property damage.

- 1.** Cut hose to desired length.
- 2.** Using Gates crimp data chart #35019 (Ind), 428-7365 (Auto), select the correct coupling or visit our website to download our electronic program at www.gates.com/ecrimp.
- 3.** Place a visible mark on hose cover at the insertion length shown on the crimp data chart.

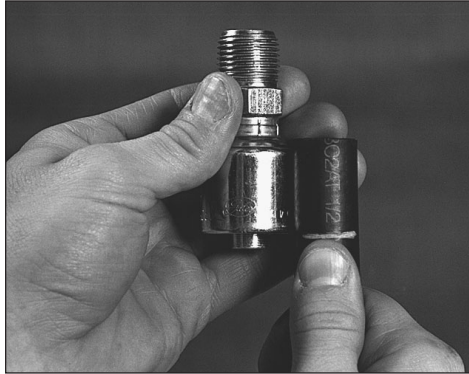

- 4.** Insert coupling into the hose until the mark lines up with the end of the coupling ferrule.



- 5.** Hose and coupling are now ready for crimping.

GlobalSpiral™ Two-Piece Couplings.

CAUTION

A new hose and end fittings (stem/ferrule) must be used when building a hose assembly. Re-using any components will seriously affect performance and could result in serious injury or property damage.

1. Cut hose to desired length.
2. Using Gates crimp data chart #35019 (Ind), 428-7365 (Auto), select the correct stem and ferrule or visit our website to download our electronic program at www.gates.com/ecrimp.
3. Place ferrule over end of hose.
4. Lubricate the first two or three serrations on stem with lightweight oil (SAE 10W).
5. Clamp stem in vise on hex portion, and push hose onto stem.

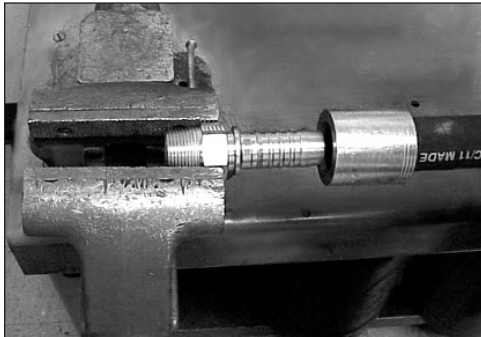

Hose should be flush against stem shoulder (see cutaway drawing below).

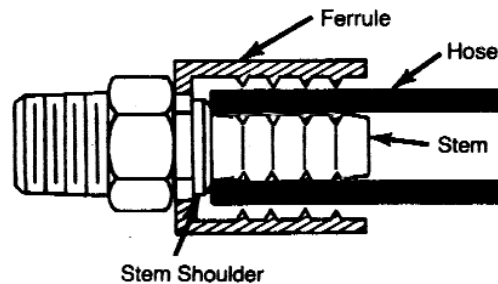
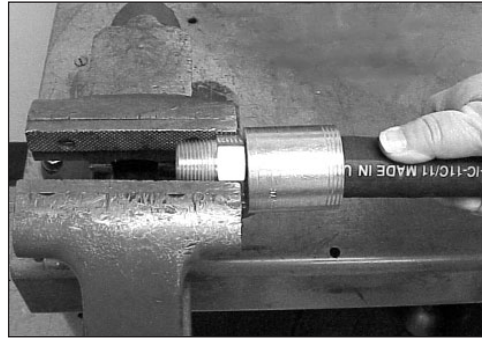

6. Hose and coupling are now ready for crimping.

Operating Instructions

1. Select correct die set.

- Using Gates crimp data chart #35019 (Ind), 428-7365 (Auto) or ecrimp, select correct die set for the hose and coupling being crimped.

Hydraulic Hose Crimp Data
MC4-20 Digital Dial and Positive Stop Crimpers

Dash Size	Hose Description	Size (in.)	Stem Type	Ferrule Description	Part No.	Skive / Buff Length +/- .03 (in.)	Dia (in.)	Crimp		Crimper		User's Actual Setting
								Insertion Length +/- .03 (in.)	Crimp Length (in.)	Crimp OD +/- .03 (in.)	Die Set	
4C1A	1/4 4G	4G	MegaCrimp	-----	0.875 WIRE	0.93	FULL	0.895	MC21	215	R4	
4C1A	1/4 4G	4G	MegaCrimp	-----	0.875 WIRE	0.93	FULL	0.895	MC31	345	W3	
6C1A	3/8 6G	6G	MegaCrimp	-----	0.875 WIRE	0.93	FULL	0.825	MC22	235	R4	
6C1A	3/8 6G	6G	MegaCrimp	-----	0.875 WIRE	0.93	FULL	0.825	MC32	235	R4	
8C1A	1/2 8G	8G	MegaCrimp	-----	1.250 WIRE	1.25	FULL	1.000	MC33	245	R4	
12C1A	3/4 12G	12G	MegaCrimp	-----	1.500 WIRE	1.50	FULL	1.340	MC35	250	W4	
16C1A	1 16G	16G	MegaCrimp	-----	1.750 WIRE	1.75	FULL	1.750	MC37	240	B4	
3C3A	3/16 3PC	3PC2F-2	80416	-----	0.750 WIRE	---	FULL	0.695	MC31	265	W4	
3C3C	3/16 3PC	3PC2F-2	80415	-----	0.750 0.425	---	FULL	0.690	MC31	275	W4	
4C3C	3/16 4PC	4PC2F-2	80416	-----	---	---	FULL	0.820	MC31	195	W5	
4C3C	1/4 4PC	4PC2F-2	80416	-----	---	---	FULL	0.690	MC31	335	R3	
4C3C	1/4 4PC	4PC2F-2	80416	-----	---	---	FULL	0.690	MC21	205	B7	

die set

- Using the magnet, place the die set into the die cone.



- Remove magnet by lifting the "T" handle, making sure the top of the die fingers are even.

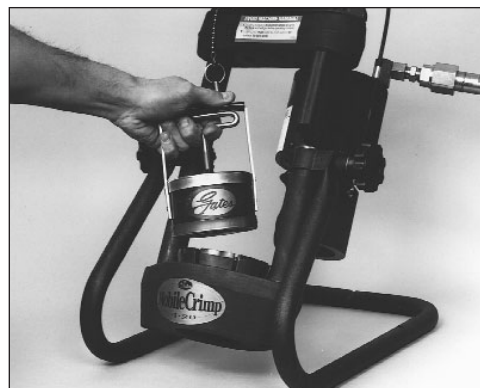

2. Lubricate and load die.

- Swing cylinder to "die loading" position.
- Apply thin layer of Molykote* lube to the inside surface of the die cone. Re-apply lube whenever surface becomes shiny.



- Apply a thin layer of Molykote lube to the top of the die set.



THINK SAFETY!

Important Note:

Lubricants should be reapplied to metal-to-metal sliding surfaces whenever the surface becomes shiny. Failure to do this reduces the life of the dies and cone. Excessive wear on these components produces poorly performing hose assemblies that could blow apart and result in injury.

* Use only Gates Molykote lube for proper operation or Gates-recommended grease.

3. Select correct setting.

- Using Gates crimp data chart #35019 (Ind), 428-7365 (Auto) or ecrimp, select correct setting for the hose and coupling being crimped.

Hydraulic Hose Crimp Data
MC4-20 Digital Dial and Positive Stop Crimpers

setting

Hose		Stem		Ferrule		Skive / Buff		Crimp			Crimper			
Dist. Size	Description	Size (in.)	Type	Description	Part No.	Length +/- .03 (in.)	Dia. (in.)	Insertion Length +/- .03 (in.)	Crimp Length	Crimp OD +/- .03 (in.)	Die Set	4.20 Digital Setting	4.20 Spacer Ring	User's Actual Setting
4C1A		1/4	4G	MegaCrimp		0.875	WIRE	0.93	FULL	0.895	MC21	215	R4	
4C1A		1/4	4G	MegaCrimp		0.875	WIRE	0.93	FULL	0.895	MC31	345	W3	
6C1A		3/8	6G	MegaCrimp		0.875	WIRE	0.93	FULL	0.825	MC22	235	R4	
6C1A		3/8	6G	MegaCrimp		0.875	WIRE	0.93	FULL	0.825	MC32	235	R4	
8C1A		1/2	8G	MegaCrimp		1.250	WIRE	1.25	FULL	1.000	MC33	245	R4	
12C1A		3/4	12G	MegaCrimp		1.500	WIRE	1.50	FULL	1.340	MC35	250	W4	
18C1A		1	18G	MegaCrimp		1.750	WIRE	1.75	FULL	1.750	MC37	240	B4	
3C2A		3/16	3PC	3PC2F-2	80416	0.750	WIRE	0.750	FULL	0.895	MC31	265	W4	
3C2		3/16	3PC	3PC2F-2	80416	0.750	0.425	0.750	FULL	0.890	MC31	275	W4	
4C3C		3/16	3PC	4PC2F-2	80416	0.750	0.425	0.750	FULL	0.820	MC31	195	W5	
6C3C		1/4	4PC	4PC2F-2	80416	0.875	0.425	0.875	FULL	0.890	MC31	335	R3	
8C3C		1/4	4PC	4PC2F-2	80416	0.875	0.425	0.875	FULL	0.890	MC21	205	B7	

- Settings are approximate and may need to be adjusted. See Measuring and Adjusting the Crimp Diameter Section (p. 13).

THINK SAFETY! **IMPORTANT SAFETY NOTE:**

All settings are approximate! Machining tolerances exist for each crimper, die set and supporting piece of equipment which will affect your actual setting. Always check the crimp diameter to ensure that it is within the published limits. Record your actual crimper setting to achieve the specified crimp diameter for future use. Failure to heed this message could result in improperly made assemblies, blowing the hose out of the fittings at high pressure, and risk of fire and/or serious injury.

4. Dial in setting and install pressure plate.

- Turn the knob on the controller to the selected setting.

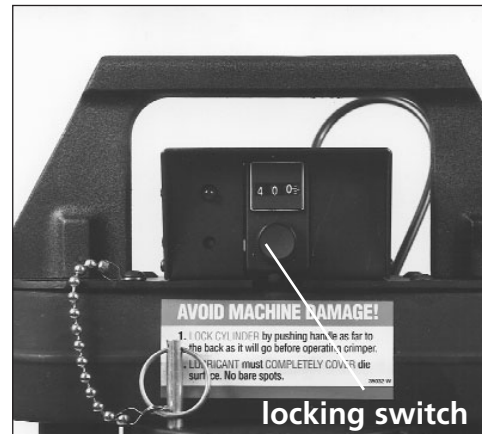

- If crimping multiple assemblies, move the locking switch to the right to hold the setting. Moving switch to the left allows the setting to be changed.
- Place the pressure plate onto the die set.



5. Insert hose assembly.

- Insert assembly from the bottom of the die cone up through the die set.



- Locate the top of the ferrule approximately 1/16" below the top of the die set.



IMPORTANT

For GS couplings, make sure the top of the ferrule rests against the hex or round shoulder of the coupling.

- When crimping bent tube and block-style couplings, keep thread end aligned with notch in pressure plate.



6. Swing cylinder into crimping position.

- Using the handle, swing cylinder toward you and lock into place with lock pin.



- Make sure cylinder is locked into position by placing lock pin into hole on top of cylinder.

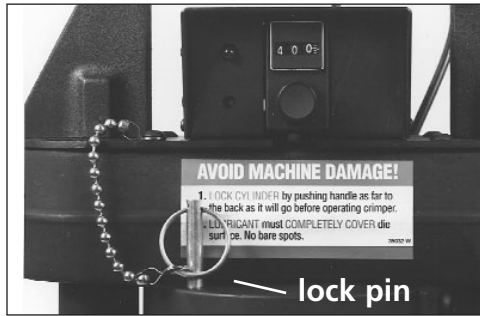

IMPORTANT

Serious injury and/or crimper damage can result if the cylinder is not locked in its crimp position.

7. Begin the crimp.

- Start pump by steadying hose with one hand while pressing and holding the power "on" switch with the other hand, which extends the ram (see pump operation manual for switch location).



CAUTION

Keep away from all moving parts!
If bodily contact with a moving part occurs, immediately release the pump power "on" switch.

Incorrect

Correct

- When light comes on and buzzer sounds, **immediately** release the power "on" switch. Crimp is now complete.
NOTE: If light and buzzer become faint or do not work, the controller batteries may need replacement. See Maintenance Section (p. 14).

8. Remove hose assembly.

- While holding hose, lightly lift bottom of die set to release hose assembly.
- Remove hose assembly.



Measuring and Adjusting the Crimp Diameter

NOTE:
DO NOT measure on top of part number stamps.

1. Measure the crimp diameter.

When using 21 and 22 Dies

- Using Gates "21/22" dial calipers (Product No. 7369-1320, Part No. 78217) measure halfway between ridges (Fig. 1). To be sure crimp diameter is being properly measured, mark a crimp flat. Beginning with that flat, count 9 flats to get the diameter. Be sure caliper blades DO NOT touch ridges. (See Photo 3.)

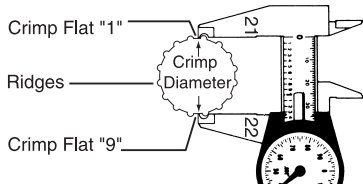

FIG. 1

- Measure halfway between the ends of crimped portion of the ferrule (Fig. 2).



FIG. 2

When NOT using 21 and 22 Dies

- Using Gates dial calipers (Product No. 7369-0320, Part No. 78215) which are notched to clear ridges, measure halfway between ridges (Sketch 1). Be sure caliper fingers DO NOT touch ridges or part number stamps. (See Photo 3.)

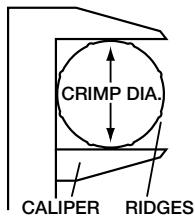

SKETCH 1

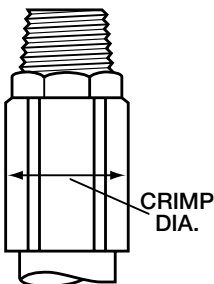

SKETCH 2

- Measure halfway down the crimped portion of the ferrule (Sketch 2).

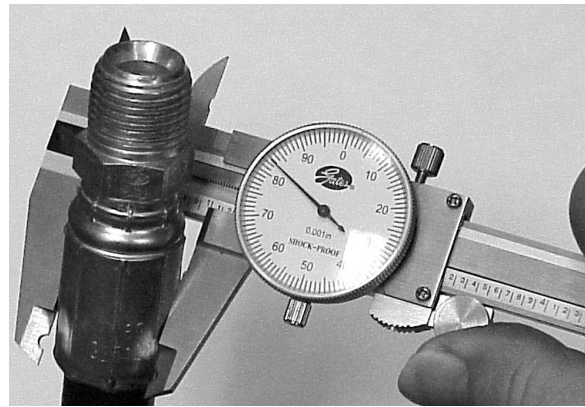

PHOTO 3

2. Check crimp diameter.

- The measured crimp diameter must be within 0.010" of the published crimp diameter. If not, the hose assembly cannot be used, and adjustment will be required.

3. Adjust the crimp diameter (if necessary).

- Check top of die set and the surfaces of the pressure plate for any debris (metal chips, dirt, etc.). Debris may cause some variation in crimp diameter.
- If necessary, clean the surfaces and lightly lubricate with Molykote.
- If the machine is properly calibrated, a slight adjustment to the crimp setting can be made.
- To get a smaller crimp diameter, change the setting to a smaller number.
- To get a larger crimp diameter, change the setting to a larger number.
- For every .001" change in crimp diameter, change the setting by 002. For example, to increase the crimp diameter by .002", increase your setting from 245 to 247.
- After the correct diameter is achieved, record this new setting on your crimp data chart for future reference.

4. Multiple crimps.

- When crimping multiple assemblies, check every tenth crimp to ensure diameter is within acceptable range (± 0.010 ").

Maintenance

This crimper requires minimal maintenance. However, the following practices are recommended to ensure maximum reliability and service.

Lubricate.

- Using the small brush and Molykote, apply a light coat to the inside surface of the die cone whenever it becomes shiny.

Check oil level.

- Check the hydraulic oil level in the pump reservoir after each 10 hours of use (see pump operation manual for instructions).
- If the oil is more than 1/2" below the top, add a high-grade hydraulic oil, such as Mobil DTE 25, until within 1/2" of the top of the reservoir.

Change the oil.

(NOTE: Frequency depends on the pump's general working conditions, severity of use and overall cleanliness.)

- For general shop conditions, change oil every 300 hours. For field/mobile conditions, more frequent changes are required.
- Drain, clean and refill the reservoir per pump operating instructions with a high-grade hydraulic oil, such as Mobil DTE 25 until within 1/2" of the top of the reservoir.

Inspect die sets and pressure plate.

- Periodically inspect the surfaces of die sets and pressure plate for debris (metal chips, dirt, etc.) or damage.
- If debris is present, clean and lightly lubricate. If damaged, replacement is required (see parts list for ordering information).

- Inspect the die links, springs and shoulder screws monthly to see if they are broken, cracked or missing. These conditions may affect crimp quality. Replace if necessary.

Inspect hose assembly.

- Inspect hose assembly connecting the crimper and pump monthly (more often with severe use).
- Check nylon sleeve for cuts or abrasion.
- If sleeve is damaged, check hose for damage.
- If hose has any signs of damage, replace immediately. A damaged hose may rupture and cause serious injury.
- If hydraulic oil is present on the hose assembly, serious damage may exist. Replace immediately.

Battery replacement.

- If light and buzzer become faint or do not work, batteries may need replacement. The controller uses two (2) AAA batteries.
- Remove the two (2) screws located on the lower left side of the controller.
- Remove the side cover and the batteries from their holder.



- Replace the batteries and position as shown on the holder.
- Replace and secure the side cover.

Troubleshooting

All equipment is tested for proper performance before it is shipped from the factory. However, if you experience any difficulties,

check the list below to help restore equipment to proper operating standards.

Problem	Correction
<ul style="list-style-type: none"> Ram will not fully extend. 	<ul style="list-style-type: none"> Check hydraulic oil level in pump reservoir. Hydraulic oil temperature must be within +40° F and +120° F.
<ul style="list-style-type: none"> Ram will not retract. 	<ul style="list-style-type: none"> Unplug pump from electrical outlet. (WARNING: pump must be unplugged to avoid risk of injury.) Slowly and carefully loosen hose at pump. Be prepared to catch oil as it escapes. If ram retracts, pump valve may be stuck or need replacement.
<ul style="list-style-type: none"> Pump motor will not start. 	<ul style="list-style-type: none"> Check electrical connections.
<ul style="list-style-type: none"> Setting will not change. 	<ul style="list-style-type: none"> Locking switch may be engaged. Move switch to the left.
<ul style="list-style-type: none"> Light and buzzer do not work. 	<ul style="list-style-type: none"> Replace the controller batteries. See Maintenance Section. Replace controller.

Replacement Parts List

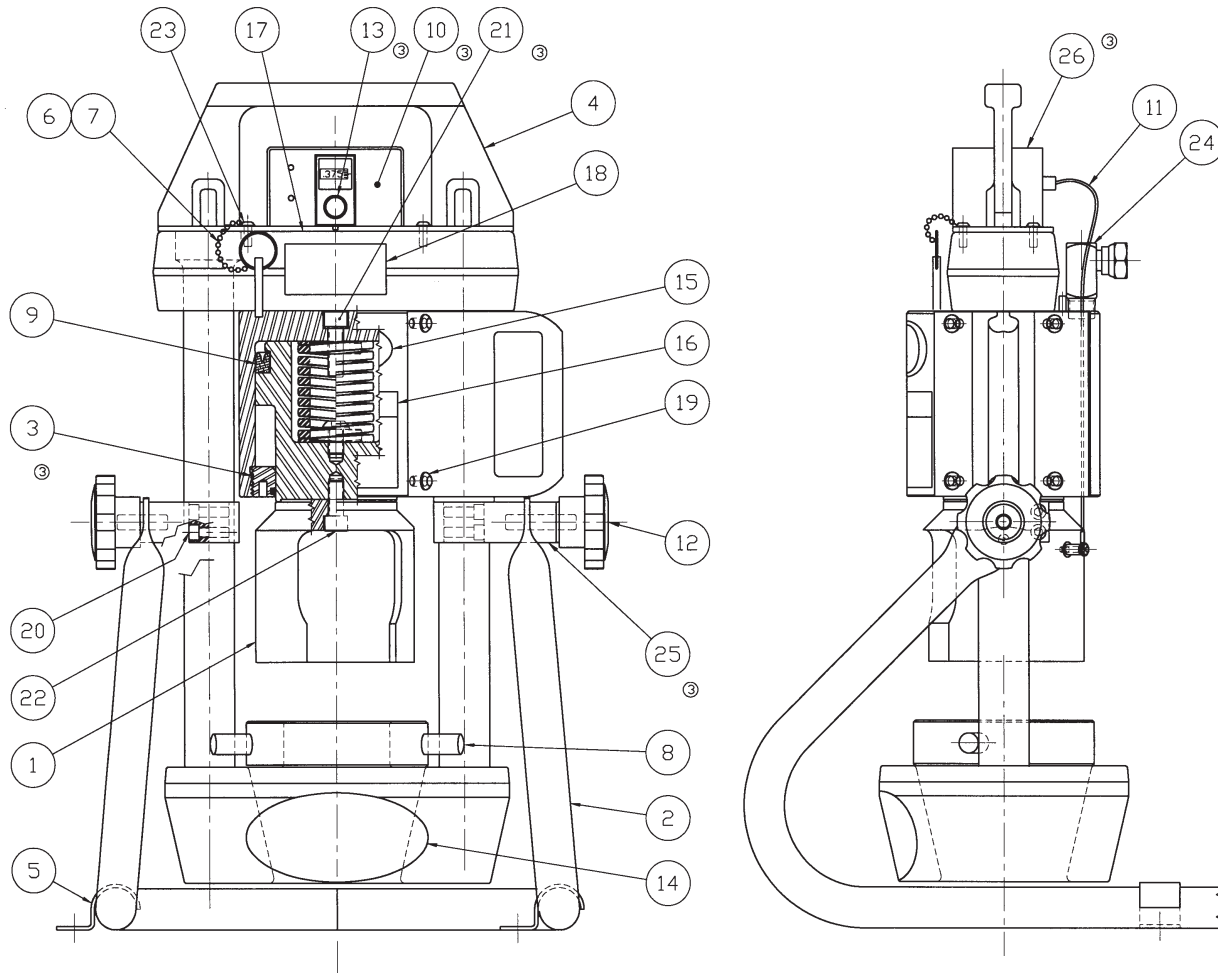

STANDARD ITEMS				
ITEM NO.	PROD NO.	PART NO.	DESCRIPTION	QTY
1	7482-1036	78437	PUSHER	1
2	7482-1005	78455	STAND	1
3	7482-1190	78425	RETAINING RING KIT	1
4	7482-1163	78420	HANDLE	1
5	7482-1009	78459	STAND CLAMP	2
6	7482-1164	78421	LOCK PIN	1
7	7482-1165	78422	CHAIN, LOCK PIN	1
8	7482-1015	78465	PRESSURE PLATE	1
9	7482-1041	78440	SEAL KIT	1
10	7482-1171	78397	DIGITAL DIAL CONTROLLER ASS'Y.	1
11	7482-1168	78424	CABLE ASS'Y, DD CONTROLLER	1
12	7482-1012	78462	PIVOT KNOB	2
13	7482-1097	78442	KNOB, DIGITAL DIAL	1
14	-	35032-D	CONE PLATE DECAL	1
15	-	35032-G	GATES DECAL	1
16	-	35032-DA	CYLINDER WARNING LABEL	1
17	-	35032-DB	TOP PLATE WARNING LABEL	1
18	-	35032-W	MACHINE DAMAGE WARNING LABEL	1
19	-	-	BUTTON HEAD CAP SCREW, 1/4-20 X 3/8	4
20	-	-	SOCKET HEAD CAP SCREW, 1/4-20 X 3/4	4
21	-	-	SOCKET HEAD CAP SCR, 3/8-16 X 1-1/4	1
22	-	-	SOCKET HEAD CAP SCREW, 3/8-16 X 3/4	1
23	-	-	BUTTON HEAD CAP SCREW, 10-32UNF X 3/8	4
24	7253-0216	86319	ADAPTER, 6MP-6FPX90, GATES	1
25	7482-1006	78456	PIVOT SPACER	2
26	7482-1172	78398	COVER, DD CONTROLLER	1
*	7482-1017	78467	HOSE ASSEMBLY, 4 FT.	1
*	7482-1155	78429	HOSE ASSEMBLY, 8 FT.	1
*	7482-1000	78450	MAGNET	1

OPTIONAL ITEMS				
PROD NO.	PART NO.	DESCRIPTION	QTY	
7482-1131	78468	MC31 DIE SET ASSEMBLY	-	
7482-1132	78469	MC32 DIE SET ASSEMBLY	-	
7482-1133	78470	MC33 DIE SET ASSEMBLY	-	
7482-1134	78471	MC34 DIE SET ASSEMBLY	-	
7482-1135	78472	MC35 DIE SET ASSEMBLY	-	
7482-1136	78473	MC36 DIE SET ASSEMBLY	-	
7482-1137	78474	MC37 DIE SET ASSEMBLY	-	
7482-1138	78475	MC38 DIE SET ASSEMBLY	-	
7482-1139	78476	MC39 DIE SET ASSEMBLY	-	
7482-1140	78431	MC40 (-6AC) DIE SET ASSEMBLY	-	
7482-1141	78432	MC41 (-8AC) DIE SET ASSEMBLY	-	
7482-1142	78433	MC42 (-10AC) DIE SET ASSEMBLY	-	
7482-1143	78434	MC43 (-12AC) DIE SET ASSEMBLY	-	
7482-1144	78452	MC44 (PS) DIE SET ASSEMBLY	-	
7482-1145	78497	MC45 (GF) DIE SET ASSEMBLY	-	
7482-1147	78396	DIE SET, SPRING	8	
7482-1148	78397	DIE SET, LINK	8	
7482-1149	78398	DIE SET, SHOULDER SCREW	8	
7482-1027	78477	RUBBER DIE RING	1	
7482-1154	78399	DIE BOX	1	
7482-1120	78496	COVER	-	
7252-8830-5	G95321-0606	FEMALE QUICK CONNECT COUPLER	-	
7252-8831-5	G95311-0606	MALE QUICK CONNECT COUPLER	-	

* Not shown

Notes

Notes

Notes

Notes

Two-Year Limited Warranty on Equipment

For two years from the date of shipment of the equipment to the original user, The Gates Rubber Company will, at its option, replace or repair any unit which proves to be defective in material or workmanship, or both, at no cost to the original user of the equipment. This is the exclusive remedy. **THERE IS NO OTHER EXPRESS OR IMPLIED WARRANTY.**

ALL INCLUDING THOSE OF MERCHANTABILITY AND FITNESS FOR A PARTICULAR PURPOSE, ARE LIMITED TO ONE YEAR FROM DATE OF SHIPMENT OF THE EQUIPMENT TO THE ORIGINAL USER. LIABILITY FOR CONSEQUENTIAL AND INCIDENTAL DAMAGES UNDER ANY AND ALL WARRANTIES IS EXCLUDED TO THE EXTENT EXCLUSION IS PERMITTED BY LAW.

Some states do not allow the exclusion of incidental or consequential damages, and some states do not allow limitations on how long an implied warranty lasts, so the above limitation and exclusion may not apply to you. This warranty gives you specific legal rights and you may also have other rights which vary from state to state. For warranty service, contact Service Department, The Gates Rubber Company, 990 S. Broadway, P.O. Box 5887, Denver, Colorado 80217.

How to Order Repair Parts

All parts for MobileCrimp® 4-20 machine listed in current replacement parts price sheets can be ordered directly from The Gates Rubber Company, Iola Distribution Center, 999 Michigan Ave., P.O. Box 606, Iola, KS 66749, Phone (316) 365-6961.

When ordering, be sure to include the following information:

1. Name of unit shown on front.
2. Product number of parts needed.
3. Description of parts needed.
4. Quantity of parts needed.
5. Serial number of machine.

For selling prices on inventoried parts, refer to Hydraulic Power Crimp Equipment and Parts List Price Schedule. Selling prices for parts not shown in these lists will be furnished on request, or parts will be shipped at prevailing prices and you will be billed accordingly. For information regarding prices, contact your local Gates representative or The Gates Rubber Company, 990 South Broadway, P.O. Box 5887, Denver, Colorado 80217.

When returning inoperable equipment, contact your Gates sales representative and request a return goods authorization form. Fill out and send to:

The Gates Rubber Company
ATTN: Service Department
Unit 29 Receiving
901 S. Broadway
Denver, Colorado 80209-4009





The world's most trusted name in belts, hose and hydraulics.

The Gates Rubber Company
P.O. Box 5887
Denver, Colorado 80217-5887

428-7560 (Auto)
35032-DD (Ind)
9/02